

SIRUBA®

銀爺牌工業用縫紉機







INDUSTRIAL SEWING MACHINE

L819

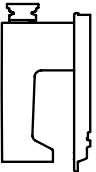
零件圖 PARÇA LİSTESİ

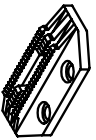
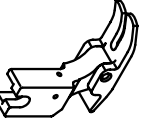

高林股份有限公司
KAULIN MFG. CO., LTD.

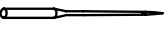
								
MODEL	SUB-CLASS	NEEDLE PLATE	FEED DOG	PRESSER FOOT	HOOK ASM	BOBBIN CASE ASM	BOBBIN	NEEDLE
機型	規格	針板	送具	押具	梭頭	梭殼	梭子	針號
L819-X1	厚布料	E702	D702	P711/P712	G112	G201	G301	DB*1#21
L819-X2		E702	D702	P711/P712	G131	G204	G304	DB*1#21

型別件對照表 MODEL KARŞILAŞTIRMA LİSTESİ

MODEL	SUB-CLASS	BAD	THRAD TAKE UP LEVER COVER	THREAD PLATE	THREAD PLATE	THREAD PLATE	THREAD PLATE	THREAD PLATE	THREAD PLATE	MOVABLE KINFE BRACKET	FIXED KINFE	FIXED KINFE
機 型	規 格	機體下座	天秤蓋	導線片	導線片	導線片	導線片	導線片	導線片	活動刀轉座	固定刀	固定刀
L819 /X1	厚布料	GLA101	GLA11F	GLA34	—	GLA125	—	—	—	—	—	—
L819 /X2		GLA501	GLA511	—	GYA24	—	GYA25	—	—	—	—	—
L819-TRIMMER /X1		GLA101P	GLA11F	GLA34	—	GLA125	—	—	—	LU100D	—	—
L819-TRIMMER /X2		GLA501P	GLA511	—	GYA24	—	—	GYA25	—	LU500	—	—

MODEL	SUB-CLASS	FIXED KINIFE FIXED BRACKET	FIXED KINIFE FIXED BRACKET	THRAD TAKE UP LEVER	NEEDLE PLATE	BELT PLATE SPRING	MOVABLE KINIFE	
機 型	規 格	固定刀固定座	固定刀固定座	天 秤	針線導片	板狀彈簧	活 動 刀	
L819 /X1	厚布料	—	—	LG113	—	LM08	—	
L819 /X2		—	—	LG513	—	LM26	—	
L819-TRIMMER /X1		LU118D	—	LG113	LU102	—	LU100D	
L819-TRIMMER /X2		—	A LU118 B SK718 C LU119	LG513	LU502	—	LU500	

型別件對照表 MODEL KARŞILAŞTIRMA LİSTESİ

型別件對照表 MODEL KARŞILAŞTIRMA LİSTESİ

X1 / X2

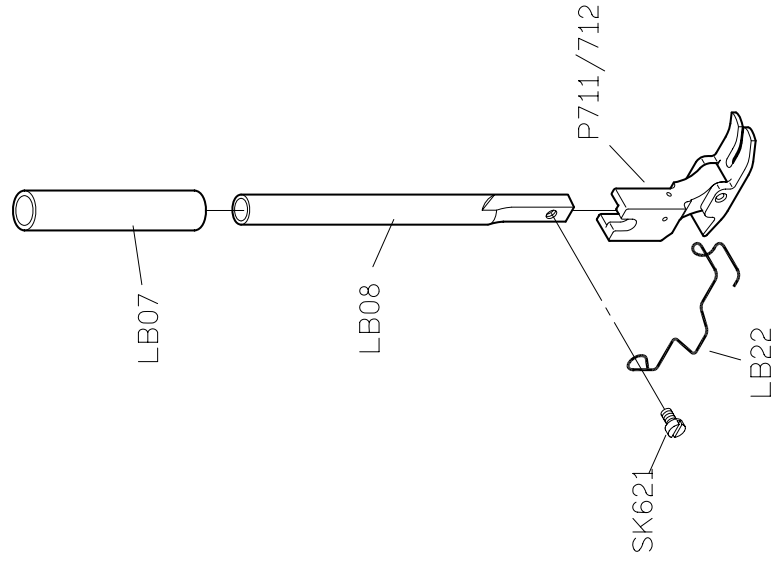

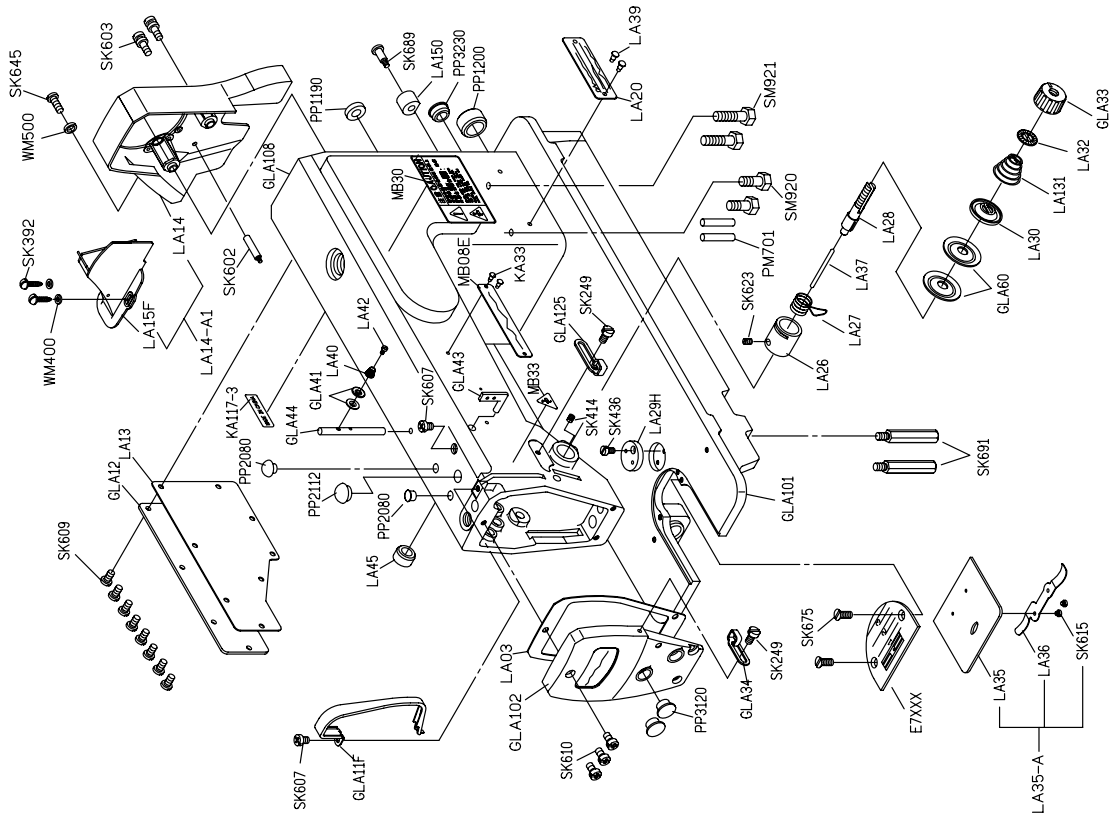

LA GRUP İÇİN PARÇA LİSTESİ

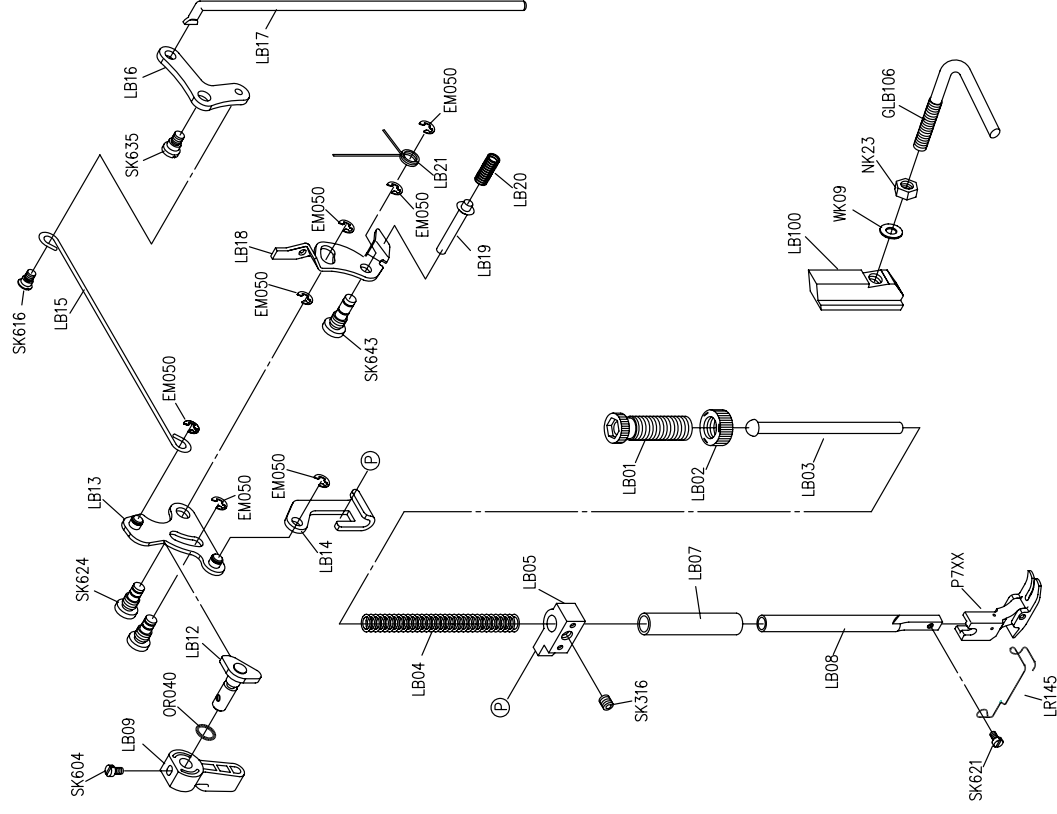

LB GRUP İÇİN PARÇA LİSTESİ

LC GRUP İÇİN PARÇA LİSTESİ

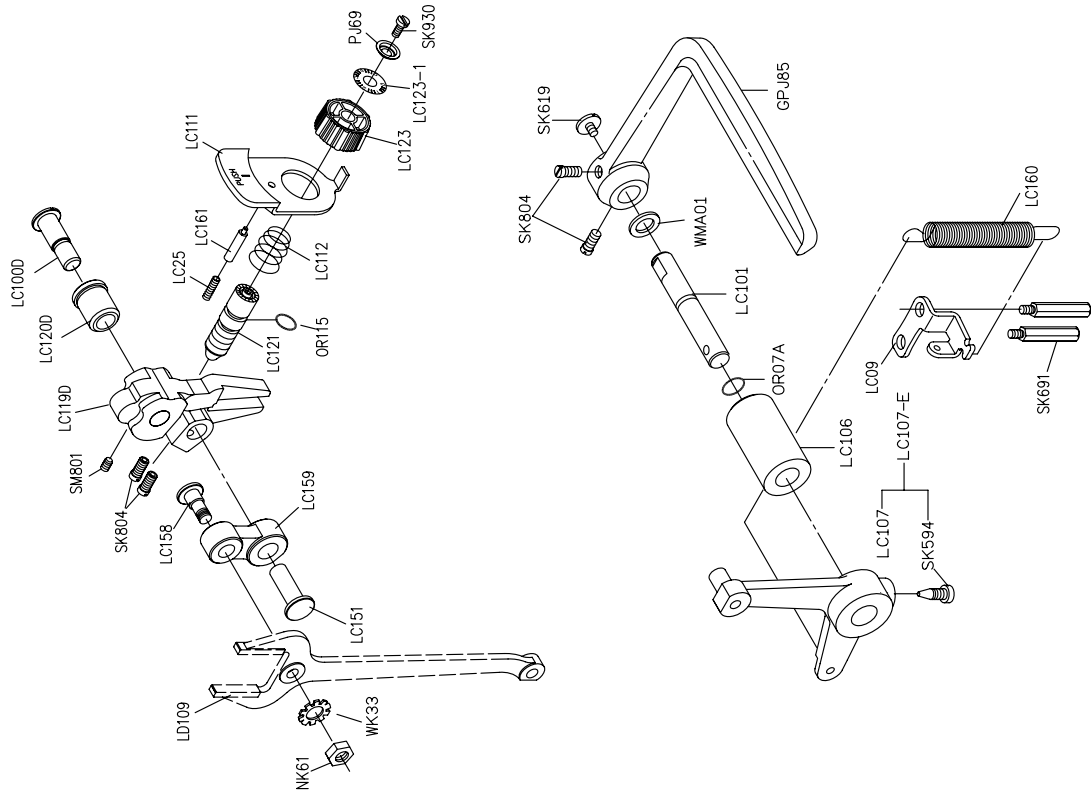

LD GRUP İÇİN PARÇA LİSTESİ

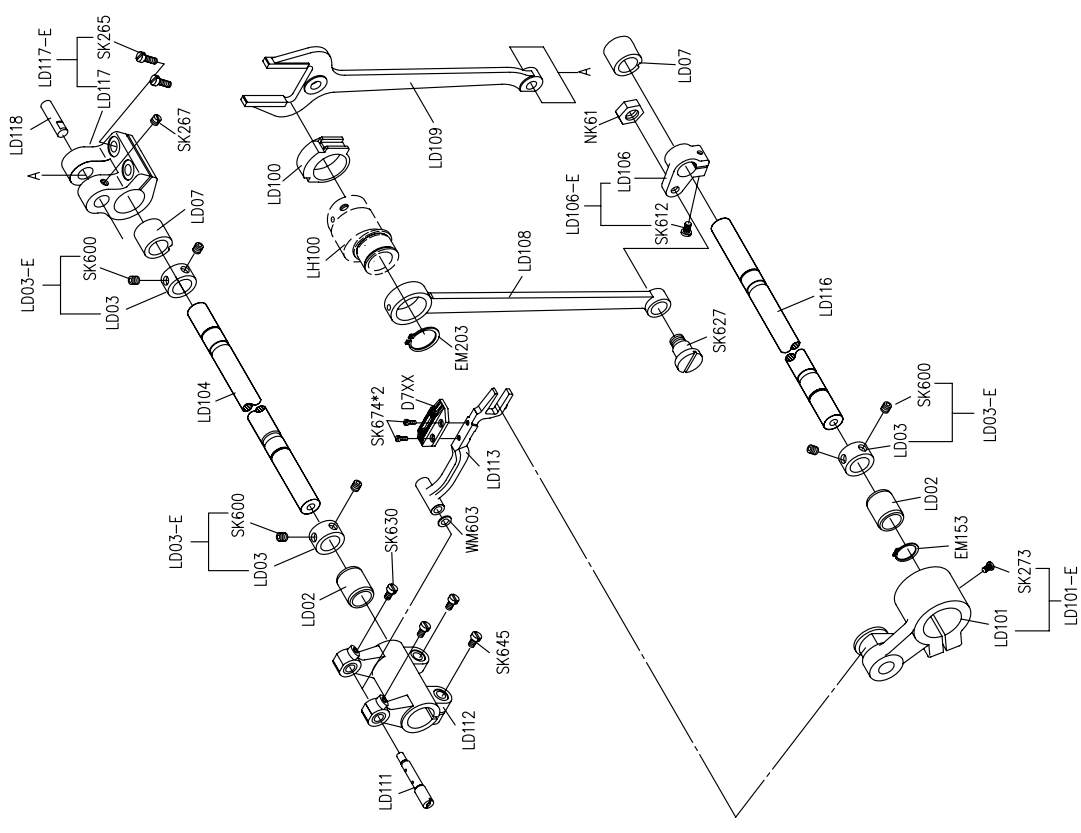

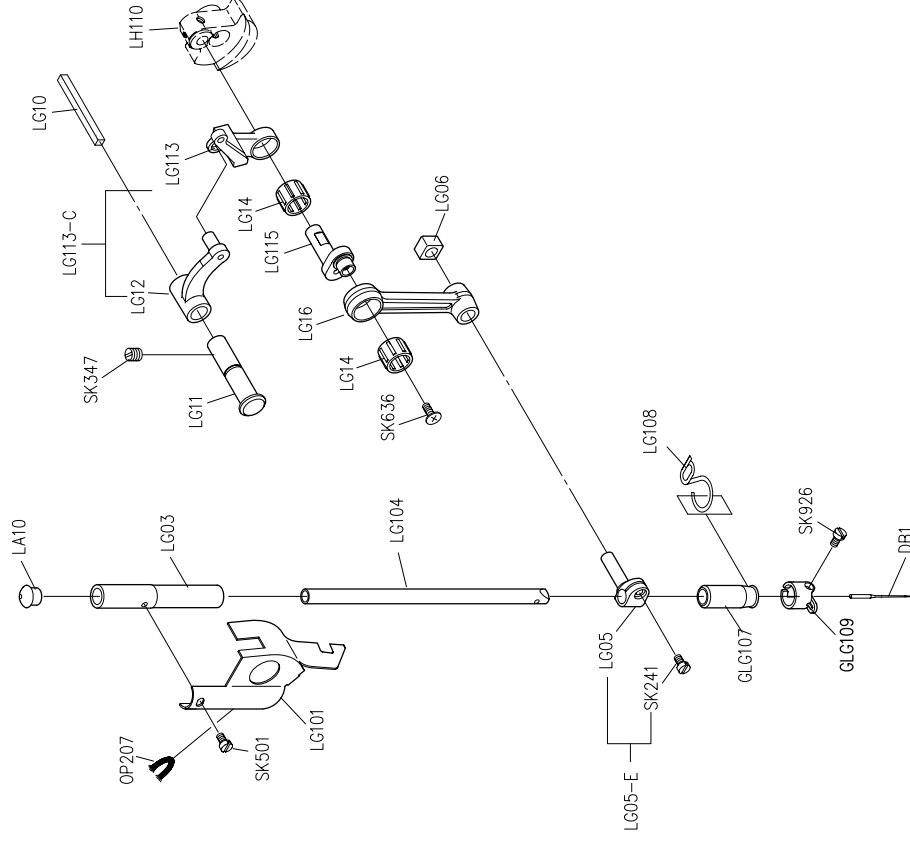
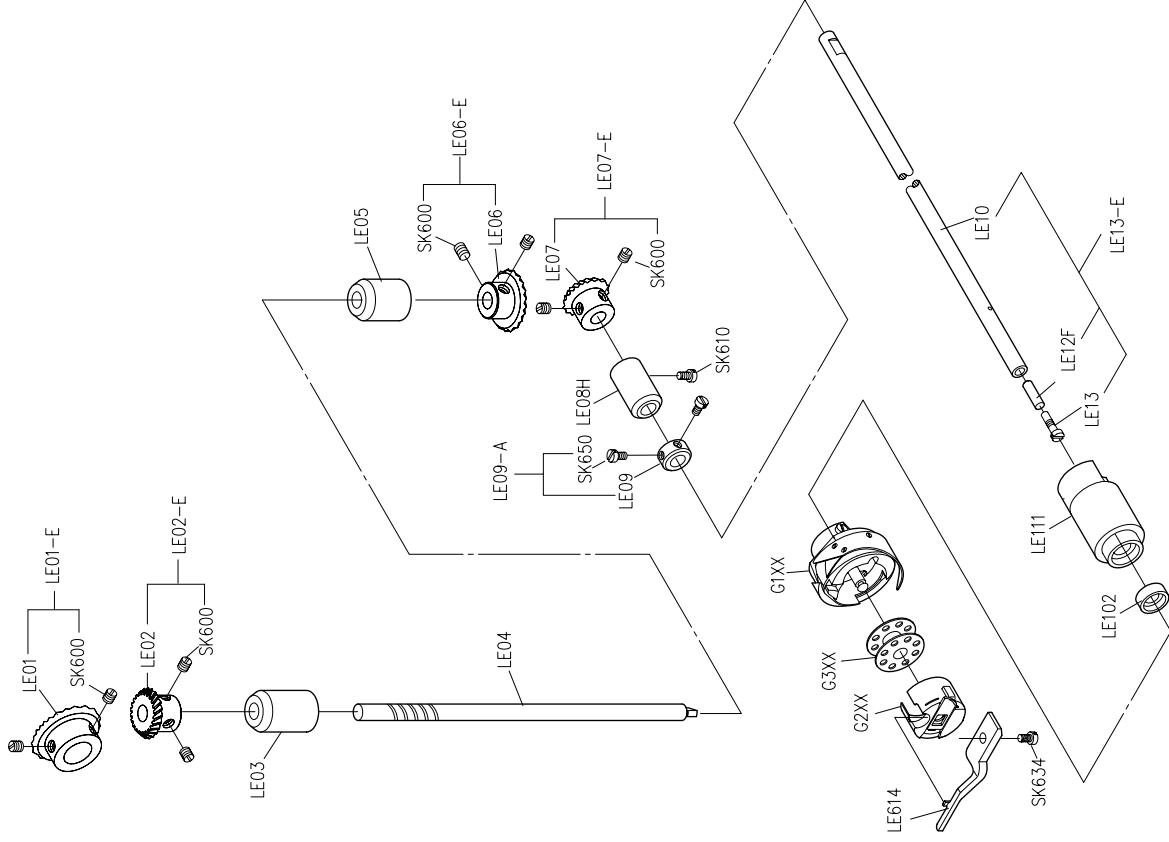

LE GRUP İÇİN PARÇA LİSTESİ

LG GRUP İÇİN PARÇA LİSTESİ

LH GRUP İÇİN PARÇA LİSTESİ

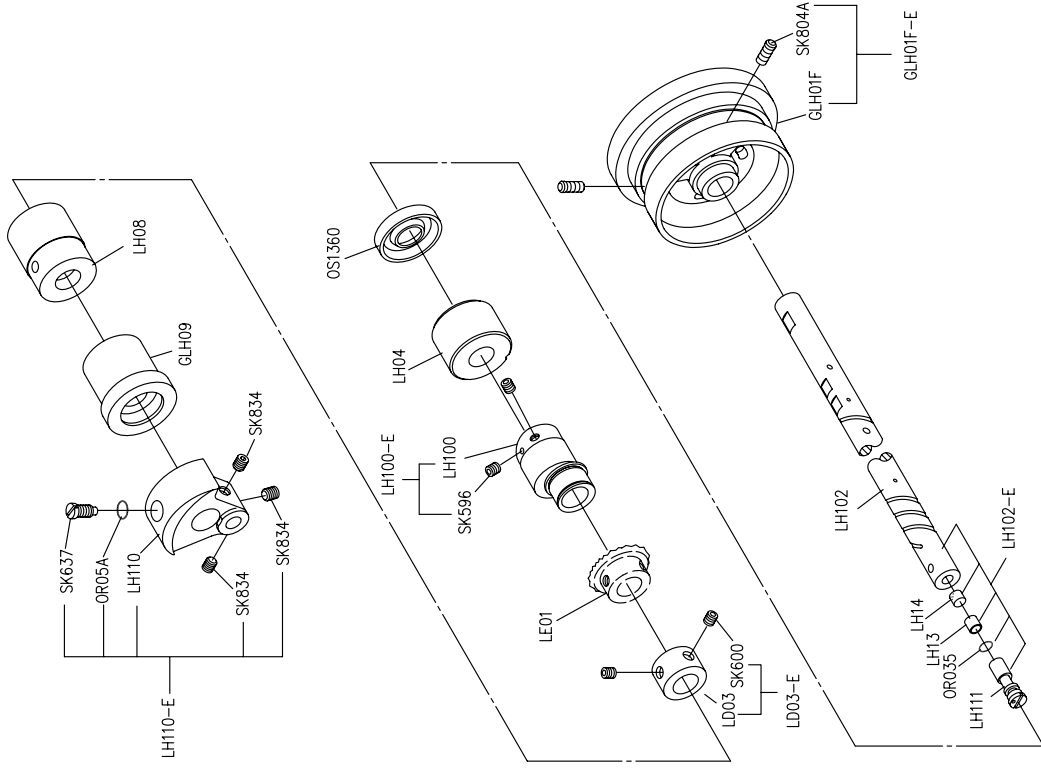

LL GRUP İÇİN PARÇA LİSTESİ

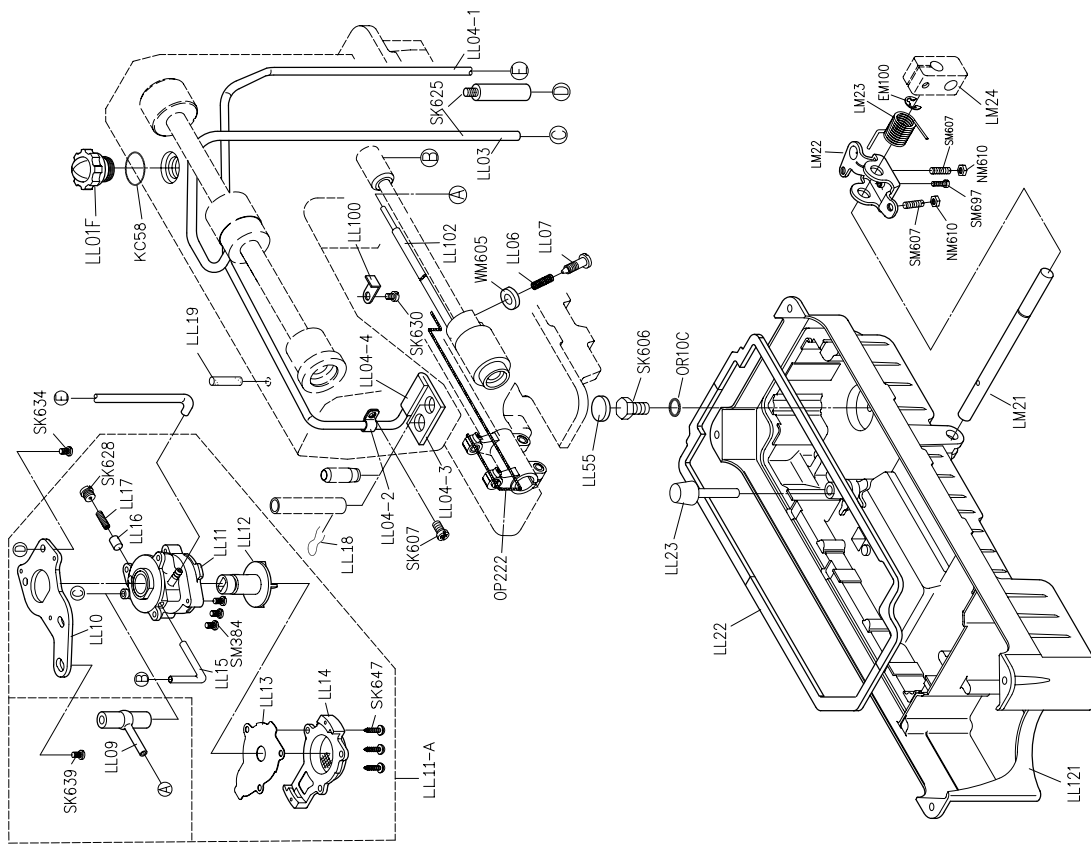

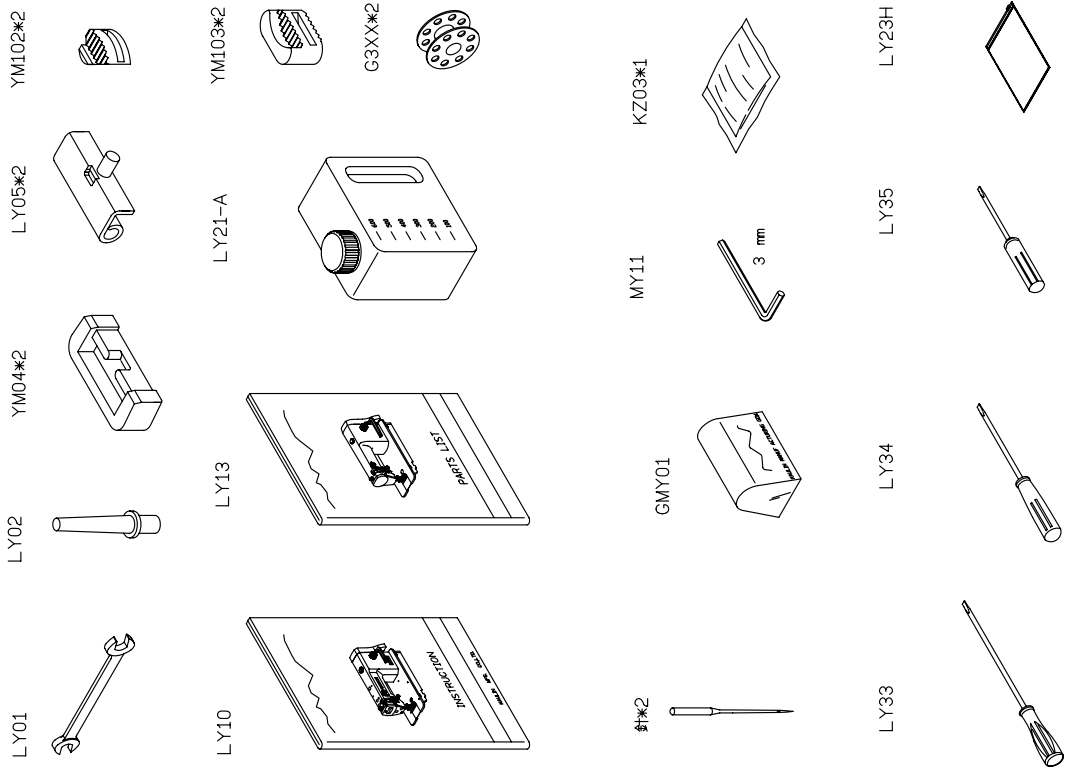
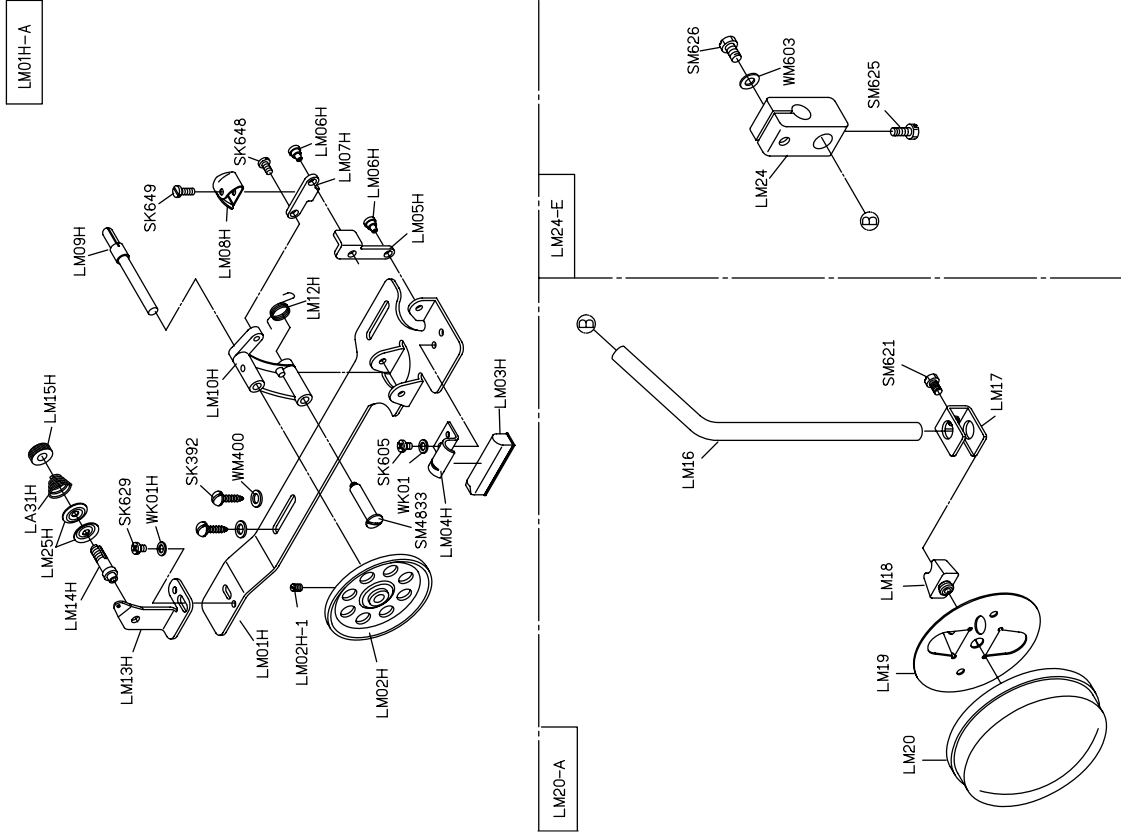

LM GRUP İÇİN PARÇA LİSTESİ

LY GRUP İÇİN PARÇA LİSTESİ

LZ GRUP İÇİN PARÇA LİSTESİ

THREAD STAND GRUP İÇİN PARÇA LİSTESİ

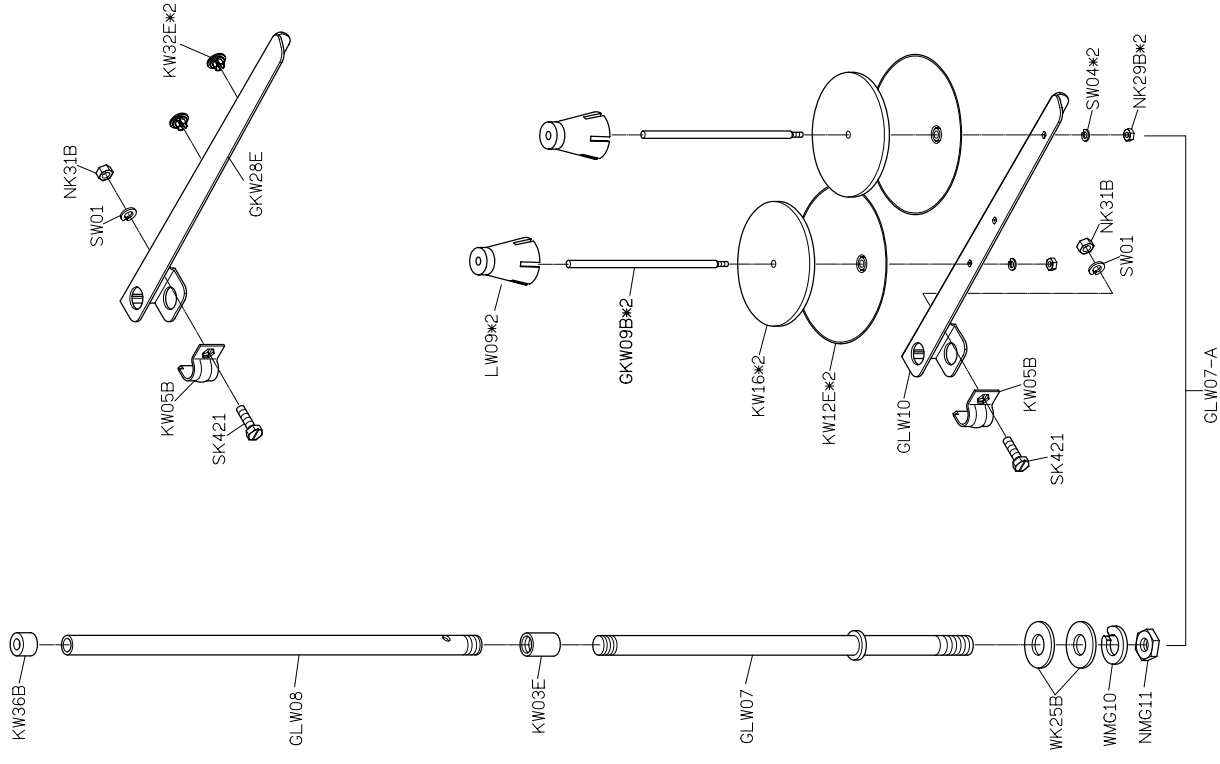
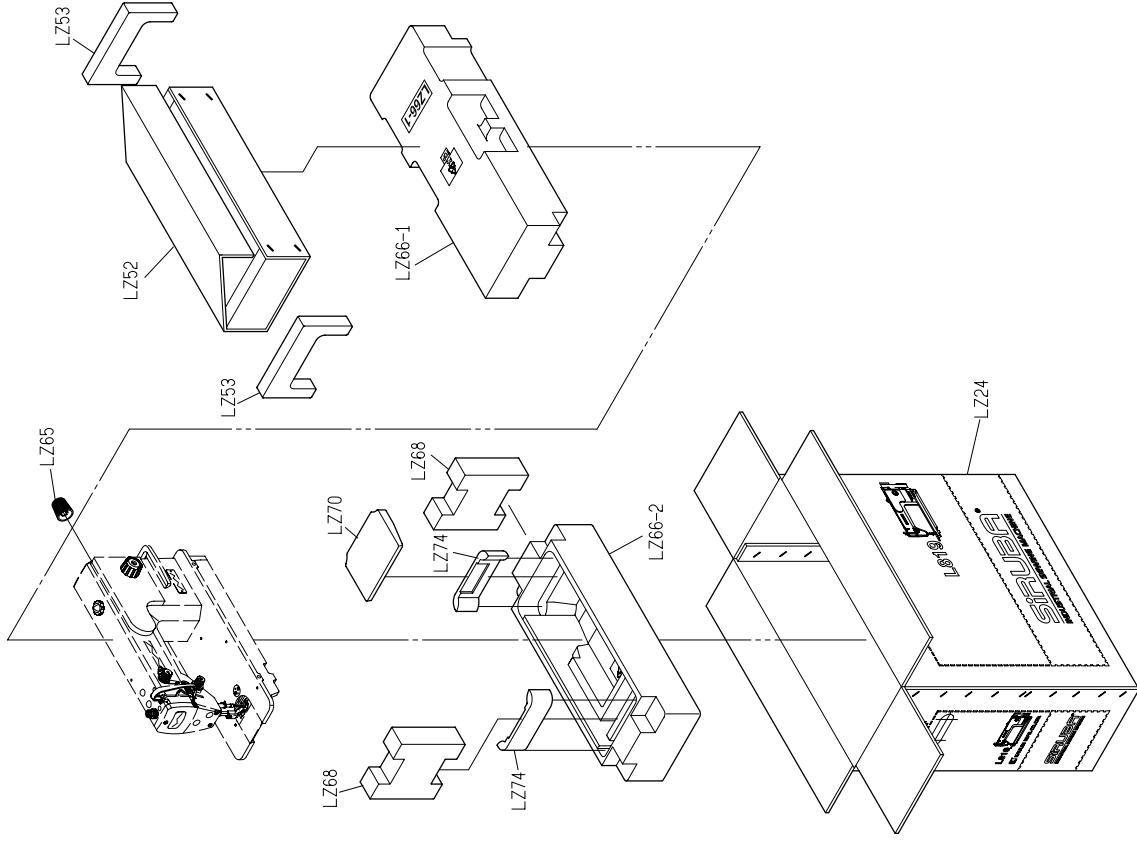



L819

高林股份有限公司 KAULIN MFG. CO., LTD.